

DS-2CD1347G3H-LIU(F)/S(L)(RB) 4 MP ColorVu 3.0 Fixed Turret Network Camera



- HikAI-ISP for excellent noise reduction effect
- Super clear 24/7 colorful imaging with ColorVu 3.0 technology
- Motion Detection 3.0, more accurate on person and vehicle classification
- Strobe Light & Audio Alarm to deter intruders
- Two-Way Audio via camera and Hik-Connect
- Smart Hybrid Light: integrates IR and white lights, 3 supplemental lighting modes
- On-board storage with SD card up to 512 GB
- Water and dust resistant (IP67)

▪ Specification

Camera	
Image Sensor	1/1.8" Progressive Scan CMOS
Max. Resolution	2560 × 1440
Min. Illumination	Color: 0.0001 Lux @ (F1.0, AGC ON)
Shutter Time	1 s to 1/100,000 s
Day & Night	IR cut filter
Angle Adjustment	Pan: 0° to 360°, tilt: 0° to 75°, rotate: 0° to 360°
Lens	
Lens Type	Fixed focal lens, 2.8 and 4 mm optional
Focal Length & FOV	2.8 mm, horizontal FOV 104°, vertical FOV 54.4°, diagonal FOV 126.7° 4 mm, horizontal FOV 89.3°, vertical FOV 48.2°, diagonal FOV 106.5°
Lens Mount	M16
Iris Type	Fixed
Aperture	F1.0
Depth of Field	2.8 mm: 2.5 m to ∞ 4 mm: 2.8 m to ∞
DORI	
DORI	2.8 mm, D: 61 m, O: 24 m, R: 12 m, I: 6 m 4 mm, D: 68 m, O: 27 m, R: 13 m, I: 6 m
Illuminator	
Supplement Light Type	IR, White Light
Supplement Light Range	Up to 30 m
Smart Supplement Light	Yes
IR Wavelength	850 nm
Video	
Main Stream	50 Hz: 25 fps (2560 × 1440, 1920 × 1080, 1280 × 720) 60 Hz: 24 fps (2560 × 1440, 1920 × 1080, 1280 × 720)
Sub-Stream	50 Hz: 25 fps (768 × 432, 640 × 360) 60 Hz: 24 fps (768 × 432, 640 × 360)
Video Compression	Main stream: H.265+/H.265/H.264+/H.264, Sub-stream: H.265/H.264/MJPEG
Video Bit Rate	32 Kbps to 16 Mbps
H.264 Type	Baseline Profile, Main Profile, High Profile
H.265 Type	Main Profile
Bit Rate Control	CBR, VBR
Region of Interest (ROI)	1 fixed region for main stream
Scalable Video Coding (SVC)	H.264 and H.265 encoding
Audio	
Audio Type	Mono sound
Audio Compression	G.711/G.722.1/G.726/MP2L2/PCM/MP3/AAC-LC
Audio Bit Rate	64 Kbps (G.711)/16 Kbps (G.722.1)/16 Kbps (G.726)/32 to 160 Kbps (MP2L2)/16 to 64 Kbps (AAC-LC)/8 to 160 Kbps (MP3)
Audio Sampling Rate	8 kHz/16 kHz

Environment Noise Filtering	Yes
Network	
Protocols	TCP/IP, ICMP, DHCP, DNS, HTTP, RTP, RTSP, RTCP, NTP, IPv4, IPv6, IGMP, UDP, QoS, FTP, SMTP
Simultaneous Live View	Up to 6 channels
API	ONVIF (Profile S, Profile G), ISAPI, SDK, ISUP
Security	Password protection, complicated password, watermark, basic and digest authentication for HTTP, WSSE and digest authentication for Open Network Video Interface, security audit log, host authentication (MAC address)
User/Host	Up to 32 users 3 user levels: administrator, operator, and user
Client	iVMS-4200, Hik-Connect
Web Browser	Plug-in required live view: Chrome 80+, Firefox 80+, Edge 89+, Safari 13+, Plug-in free live view: Chrome 80+, Firefox 80+, Edge 89+
Image	
Image Settings	Rotate mode, saturation, brightness, contrast, sharpness, gain, white balance, adjustable by client software or web browser
Day/Night Switch	Day, Night, Auto, Schedule
Wide Dynamic Range (WDR)	120 dB
SNR	≥ 52 dB
Image Enhancement	BLC, HLC, 3D DNR
Privacy Mask	4 programmable polygon privacy masks
Interface	
Ethernet Interface	1 RJ45 10 M/100 M self-adaptive Ethernet port
On-Board Storage	-F: Built-in memory card slot, support microSD/microSDHC/microSDXC card, up to 512 GB
Built-in Microphone	Yes, 1 built-in microphone
Built-in Speaker	Max. power consumption: 1.5 W, max. sound pressure level: 10 cm: 98 dB.
Reset Key	Yes
Event	
Basic Event	Motion detection (support alarm triggering by specified target types (human and vehicle)), video tampering alarm, exception
Linkage	Upload to FTP, notify surveillance center, send email, trigger recording, trigger capture
General	
Power	12 VDC ± 25%, 0.64 A, max. 7.68 W, Ø5.5 mm coaxial power plug, reverse polarity protection, PoE: IEEE 802.3af, Class 3, max. 9.21 W
Material	Cover: PLASTIC, main body: METAL
Dimension	Ø130.1 mm × 103.1 mm (Ø5.1" × 4.1")
Package Dimension	170 mm × 170 mm × 160 mm (6.7" × 6.7" × 6.3")
Weight	Approx. 580 g (1.3 lb.)
With Package Weight	Approx. 800 g (1.8 lb.)
Storage Conditions	-30 °C to 60 °C (-22 °F to 140 °F). Humidity 95% or less (non-condensing)
Startup and Operating Conditions	-30 °C to 60 °C (-22 °F to 140 °F). Humidity 95% or less (non-condensing)

Language	English, Russian, Ukrainian, Arabic, Spanish, French, Portuguese, Turkish, Polish, German
General Function	Heartbeat, mirror, flash log, password reset via email, password protection, anti-banding
Flashing Light	-SL: White Light, -SRB: Red and Blue Light
Approval	
EMC	CE-EMC: EN 55032:2015+A1:2020, EN 50130-4:2011+A1:2014, EN IEC 61000-3-2:2019+A1:2021, EN 61000-3-3:2013+A1:2019+A2:2021
Safety	CB: IEC 62368-1:2014+A11, CE-LVD: EN 62368-1:2014/A11: 2017
Environment	CE-RoHS: 2011/65/EU, WEEE: 2012/19/EU
Protection	IP67: IEC 60529-2013

▪ Available Model

- DS-2CD1347G3H-LIUF/SL(2.8mm)
- DS-2CD1347G3H-LIUF/SL(4mm)
- DS-2CD1347G3H-LIUF/SRB(2.8mm)
- DS-2CD1347G3H-LIUF/SRB(4mm)
- DS-2CD1347G3H-LIU/SL(2.8mm)
- DS-2CD1347G3H-LIU/SL(4mm)
- DS-2CD1347G3H-LIU/SRB(2.8mm)
- DS-2CD1347G3H-LIU/SRB(4mm)

▪ Dimension

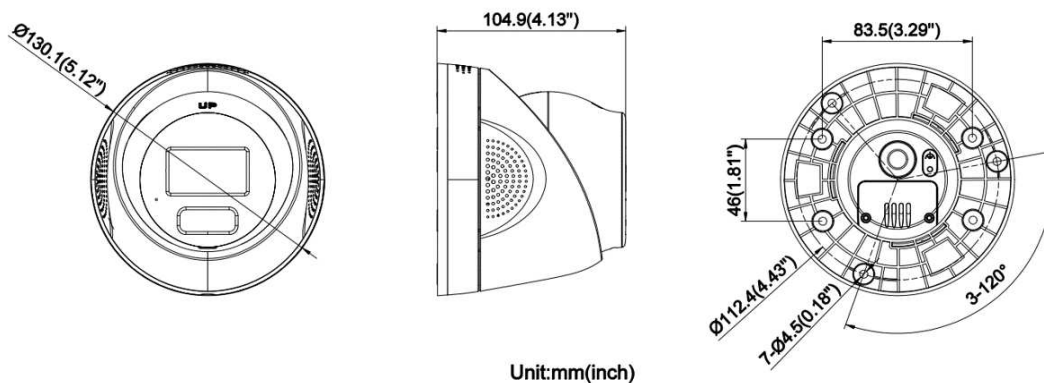











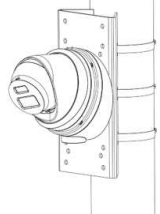

▪ Accessory

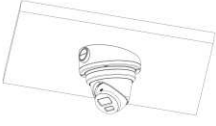
▪ Optional

- DS-1275ZJ-SUS DS-1281ZJ-M DS-1273ZJ-130-TRL DS-1271ZJ-130-TRL DS-1280ZJ-DM8

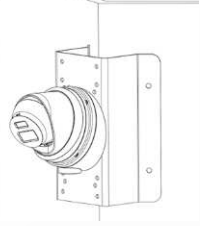
				
DS-1273ZJ-130B-T RL	DS-1276ZJ-SUS			
				

▪ **Installation Methods**

Vertical Pole Mounting DS-1275ZJ-SUS+DS-12 81ZJ-M	Vertical Pole Mounting DS-1275ZJ-SUS+DS-12 73ZJ-130-TRL	Vertical Pole Mounting DS-1275ZJ-SUS+DS-12 80ZJ-DM8	Vertical Pole Mounting DS-1275ZJ-SUS+DS-12 73ZJ-130B-TRL	Inclined Ceiling Mounting DS-1281ZJ-M
				
Wall Mounting DS-1273ZJ-130-TRL	Wall Mounting DS-1273ZJ-130B-TRL	Pendant Mounting DS-1271ZJ-130-TRL	Junction Box DS-1280ZJ-DM8	Corner Mounting DS-1276ZJ-SUS+DS-12 81ZJ-M
				
Corner Mounting DS-1276ZJ-SUS+DS-12 73ZJ-130-TRL	Corner Mounting DS-1276ZJ-SUS+DS-12 80ZJ-DM8	Corner Mounting DS-1276ZJ-SUS+DS-12 73ZJ-130B-TRL		
				

See Far, Go Further



www.hikvision.com
support@hikvision.com

